

Captrad Cable Systems

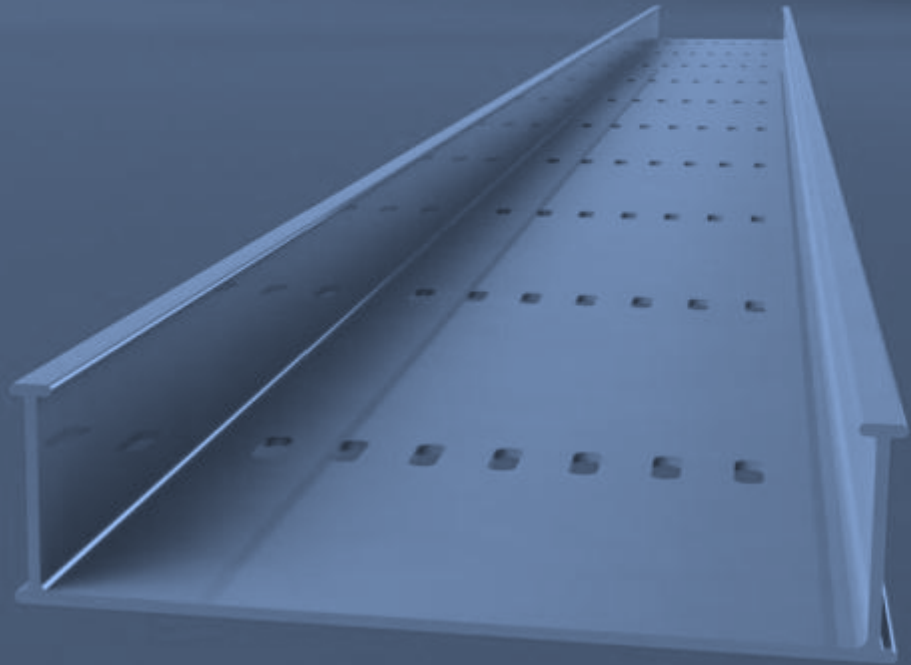

grp cable systems



Captrad Ltd

Was established in 1999 based in Wigan in the North of England. Originally Captrad Ltd supplied Industrial Chemicals into various industries across the UK., and as time passed we were always looking for new business opportunities and thus this is how we have ended up supplying a wide range of Composite Products across the worCO.

As a result Captrad Ltd has tried to bring the whole composite solution under one umbrella. Thus we now have customers from a variety of industries from: Rail, Offshore, Constructions, Civils and Water, all being able to purchase quality products from one place ensuring continuity of service.

We have been able to set up a network of satellite offices around the worCO to help improve and maintain customer service levels.

GRP Cable Systems

Captrad Cable Trays have been design and manufactured with the user in mind, whilst offering excellent performance ease of use. Our Cable Trays can be supplied in a variety of sizes along with a comprehensive array of fittings to cater for any project large or small. Captrad Cable Trays can be supplied either as the tray or with the uniquely designed 'Click-fit-Lid'. All our trays are produced in 3mtr lengths and can easily be fabricated on/off site.

Advantages

CLrosion Resistant	Impact Resistant
Strong & Lightweight	Click Fit Lid System
Non-Conductive	Easy to fabricate
Dimension Stability	UV Stability
Excellent Working Temperatures	

Markets

Alternative Energy	Industrial
Rail/Underground	Off Shore
Marine	Construction
Chemical Plant	Water Industry



GRP Cable Trays

GRP Cable Trays at a glance		
	Standard	Alternative
Material	ISO Polyester Resin	
Fire Rating	Class 2 Fire Rated	Modar
Length	3000mm	6000
Width	50-300mm	
Type	Slotted	Plain
Fittings	All Stainless Steel	

Specifications

The cable trays are manufactured glass by the pultrusion process from isophthalic polyester thermosetting resin reinforced with E glass giving a high strength dimensionally accurate and thermally stable product. The pultruded sections fully comply with all the requirements of EN13706, grade E17 – Specification of pultruded profiles.

The standard polyester resin is a halogen free fire retardant grade satisfying the requirements of BS476 Pt7, Class 2 and ASTM E84 25 sec - Surface spread of flame. Higher grade fire retardant products can be manufactured to order including the high fire resistance, low smoke and low toxicity required by the London Underground (LUL). Cable Trays can also be made to order in the highly CLrosion resistant vinyl ester resin.

GRP cable trays are normally electrical non-conductive but for those applications with risk explosive atmospheres an anti-static version is available to order.

The cable tray is slotted along the length the cable tray also has a unique accepting slot that allows couplers to be inserted with ease insitu. All cable trays have a bespoke click fit lid.

Cable Tray (without cover) distributed load in Kg over the span

SPAN (M)	1	1.5	2	2.5	3
DEFLECTION (MM)	5	7.5	10	12.5	15
Tray	UDL in Kg at this span for deflection limited to span /200				
100x50	231	103	58	37	26
150x50	247	110	62	39	27
200x50	271	121	68	43	30
300x50	294	131	74	47	33

GRP Cable Trays – Product Codes

Product	Width	Height	Kg/mtr
GRPCT10050/3	100mm	50mm	1.34
GRPCT15050/3	150mm	50mm	1.67
GRPCT20050/3	200mm	50mm	1.96
GRPCT30050/3	300mm	50mm	2.55

Product	Width	Products	Kg/each
GRPCTCO100/3	100mm	Cover	0.91
GRPCTCO150/3	150mm	Cover	1.22
GRPCTCO200/3	200mm	Cover	1.53
GRPCTCO100/3	100mm	Cover	0.91

Tray & Lid

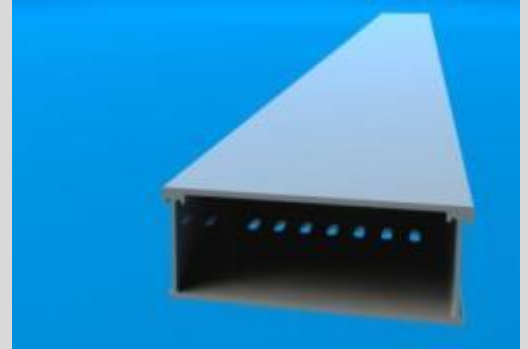

Bends

Cable Tray 90° Bend

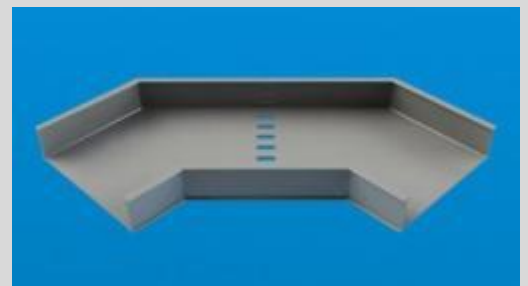

Cable Tray 45° Bend



Product	Width	Height	Kg/each
GRPCTFB90/100	100mm	50mm	0.70
GRPCTFB90/150	150mm	50mm	0.85
GRPCTFB90/200	200mm	50mm	1.15
GRPCTFB90/300	300mm	50mm	1.75

Product	Width	Height	Kg/each
GRPCTFB45/100	100mm	50mm	0.70
GRPCTFB45/150	150mm	50mm	0.85
GRPCTFB45/200	200mm	50mm	1.15
GRPCTFB45/300	300mm	50mm	1.75

External Risers

Product	Width	Height	Kg/each
GRPCTEXTR90/100	100mm	50mm	0.53
GRPCTEXTR90/150	150mm	50mm	0.64
GRPCTEXTR90/200	200mm	50mm	0.86
GRPCTEXTR90/300	300mm	50mm	1.31

Product	Width	Height	Kg/each
GRPCTEXTR45/100	100mm	50mm	0.49
GRPCTEXTR45/150	150mm	50mm	0.58
GRPCTEXTR45/200	200mm	50mm	0.75
GRPCTEXTR45/300	300mm	50mm	1.25

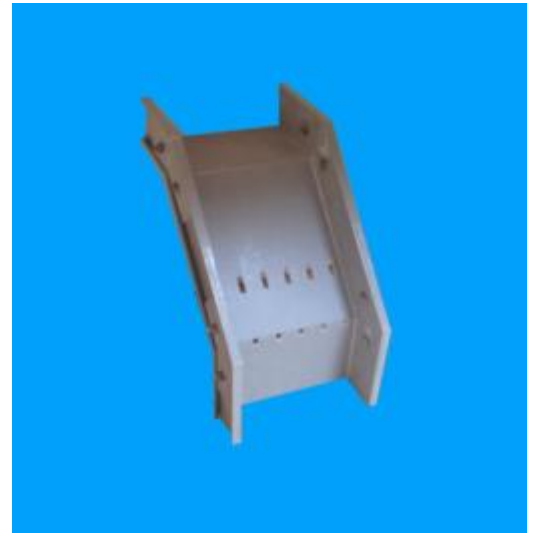

Cable Tray 90° Ext Riser (& 45°)

Internal Risers

Cable Tray 90° Int Riser

Product	Width	Height	Kg/each
GRPCTINTR90/100	100mm	50mm	0.53
GRPCTINTR90/150	150mm	50mm	0.64
GRPCTINTR90/200	200mm	50mm	0.86
GRPCTINTR90/300	300mm	50mm	1.31

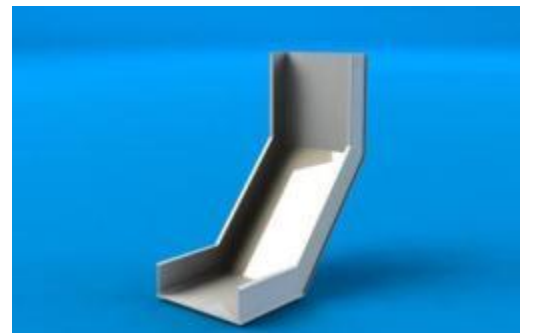

Cable Tray 45° Int Riser

Product	Width	Height	Kg/each
GRPCTINTR45/100	100mm	50mm	0.53
GRPCTINTR45/150	150mm	50mm	0.64
GRPCTINTR45/200	200mm	50mm	0.86
GRPCTINTR45/300	300mm	50mm	1.31



T-Piece

Product	Width	Height	Kg/each
GRPEQT-50-100	100mm	50mm	0.53
GRPEQT-50-150	150mm	50mm	0.64
GRPEQT-50-200	200mm	50mm	0.86
GRPEQT-50-300	300mm	50mm	1.31



Reducer

Product	Width	Height	Kg/each
GRPCTRED/150100	100mm	50mm	0.53
GRPCTRED/200150	150mm	50mm	0.64
GRPCTRED/300200	200mm	50mm	0.86



GRP Cable Troughs

150x110

Captrad Cable Ducting have been designed and manufactured with the user in mind, whilst offering excellent performance ease of use.

Captrad Cable Troughs can be supplied either as the Trough or with the uniquely designed 'Click-fit-Lid'. All our troughs are produced in 3mtr lengths and can easily be fabricated on/off site.

Advantages

CLrosion Resistant	Impact Resistant	Dimension Stability
Strong & Light weight	Click Fit Lid System	UV Stability
Non-Conductive	Easy to fabricate	Excellent working temps

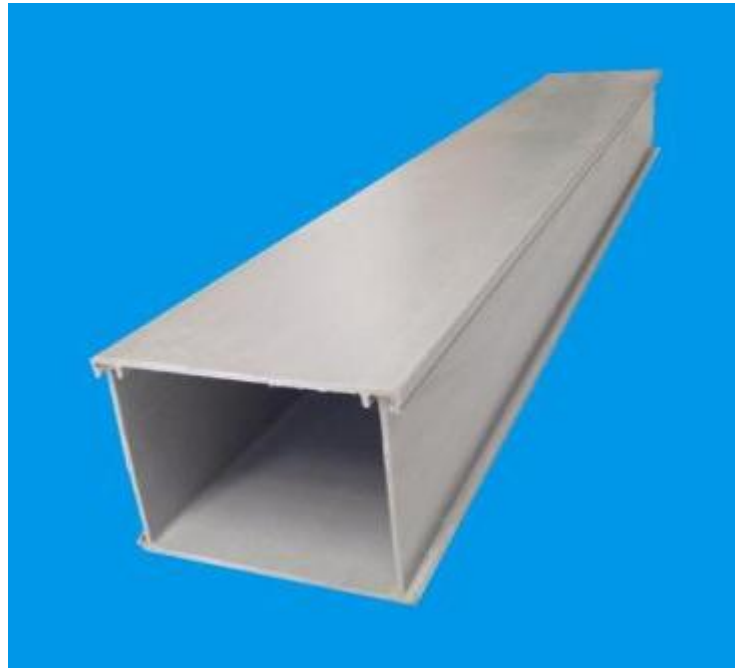

Specifications

The cable trays are manufactured glass by the pultrusion process from isophthalic polyester thermosetting resin reinforced with E glass giving a high strength dimensionally accurate and thermally stable product. The pultruded sections fully comply with all the requirements of EN13706, grade E17 – Specification of pultruded profiles.

The standard polyester resin is a halogen free fire retardant grade satisfying the requirements of BS476 Pt7, Class 2 and ASTM E84 25 sec - Surface spread of flame. Higher grade fire retardant products can be manufactured to order including the high fire resistance, low smoke and low toxicity required by the London Underground (LUL).

Cable Troughs can also be made to order in the highly CLrosion resistant vinyl ester resin. GRP cable troughs are normally electrical non-conductive but for those applications with risk explosive atmospheres an anti-static version is available to order.

Our cable trays have been by Birse Rail at Liverpool Sandhills Lane NWR , Winwick Junction Winwick, Tamworth

GRP Cable Ladders

GRP Cable Trays at a glance		
	Standard	Alternative
Material	ISO Polyester Resin	
Fire Rating	Class 2 Fire Rated	Modar
Length	3000mm	6000mm
Width	150mm – 1000mm	
Height	100mm	150mm
Fittings	All Stainless Steel	



GRP Cable Ladders are supplied from stock in a range of standard sizes which allows them to accommodate almost all projects. Our ladders systems are designed to utilize space and to give cable protection. The design of the side profile combines great strength with light weight. All of Captrad Cable Systems ladders have been designed to improve load-bearing capabilities. We are able to produce GRP Cable Ladders to a variety of sizes and special resin systems to match any working environment. We can also supply cable ladders dividers and lids if required. There are many advantages to using our GRP Cable Ladders:

- Light weight and easy to use
- Excellent UV stability and fire properties
- Various sizes available in the ladder profile
- Available in various resin systems offering excellent Corrosion resistance
- Ladders are produced to NEMA standards
- Excellent strength properties under high loads

Cable Ladders

Product	Width	Height	Kg/mtr
GRPCL100300/3	300mm	100mm	2.92
GRPCL100450/3	450mm	100mm	3.21
GRPCL100600/3	600mm	100mm	3.50
GRPCL100700/3	700mm	100mm	3.68



Bends

Cable Ladder Flat Elbow 90

Product	Width	Height	Kg/each
GRPCL90EB 100-300	300mm	100mm	3.02
GRPCL90EB100-450	450mm	100mm	3.68
GRPCL90EB100-600	600mm	100mm	4.35
GRPCL90EB100-700	700mm	100mm	4.90

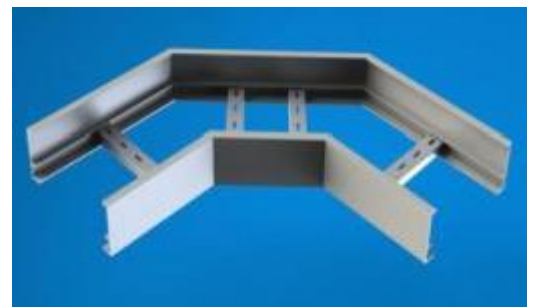

Cable Ladder Flat Elbow 45

Product	Width	Height	Kg/each
GRPCL45EB100-300	300mm	100mm	2.14
GRPCL45EB100-450	450mm	100mm	2.44
GRPCL45EB100-600	600mm	100mm	2.93
GRPCL45EB100-700	700mm	100mm	3.13



Internal Risers

Cable Ladder Int Riser 90

Product	Width	Height	Kg/each
GRPCL90INTR100-300	300mm	100mm	2.18
GRPCL90INTR100-450	450mm	100mm	2.44
GRPCL90INTR100-600	600mm	100mm	2.70
GRPCL90INTR100-700	700mm	100mm	2.86



Cable Ladder Int Riser 45

Product	Width	Height	Kg/each
GRPCL45INTR100-300	300mm	100mm	2.00
GRPCL45INTR100-450	450mm	100mm	2.26
GRPCL45INTR100-600	600mm	100mm	2.52
GRPCL45INTR100-700	700mm	100mm	2.68



T - Piece

Cable Ladder T-Piece

Product	Width	Height	Kg/each
GRPCLTP100-300	300mm	100mm	3.92
GRPCLTP100-450	450mm	100mm	4.26
GRPCLTP100-600	600mm	100mm	4.26
GRPCLTP100-700	700mm	100mm	7.12



GRP Uni Strut Profiles

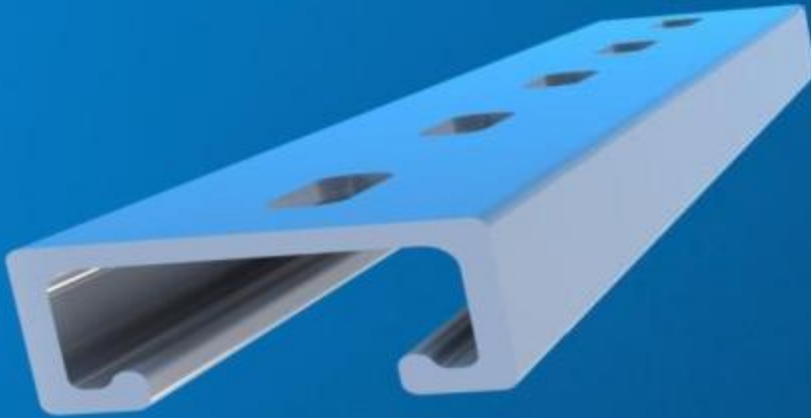

GRP Uni-Strut type profile

Product description

The 41x41x3.2mm mm grp uni-strut profile is made by the pultrusion process giving a section that is structurally strong and dimensionally consistent . The uni-strut profile matches the steel strut so that it takes the same shaped nuts, with and without springs that are widely available for the steel strut.

The profile meets all the requirements of EN 13706 – Specification of grp profiles – Grade E17 and is manufactured under ISO 9000 registered quality control system.

The profile is stocked in 6m lengths, colour grey.

We also have the half strut available at 41mm x 25mm x 3mm

Applications

The strut profile is electrically non-conductive and resistant to CLrosion by water, salt and most chemicals.

Typical applications include:

Support frames for cabinets hoCOing electrical switchgear, process control instruments, etc

Support for electrical cable trays and ladders

Support for pipes, conduits, etc

Mechanical Properties

Full section modulus =19GPa measured by the method- EN 13706, Annex D

Moment of inertia Ixx = 130,000mm⁴

Bolt pull out strength with Zebidee nut - 2000N

Concentrated Load at centre of span. Deflection limited to span/200

	Span mm			
	1000	1500	2000	2500
Load kg	150	65	38	25

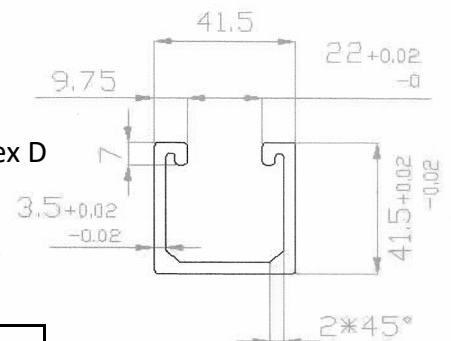

Captrad Cable Systems

A Division of Captrad Ltd
6a Gratton Place
East Gillibrands
Skelmersdale
WN8 9UE
ENGLAND

Tel: +44 (0)1695 280510

Fax: +44 (0)1695 732566

sales@captradcablesystems.co.uk

www.captradcablesystems.co.uk

www.captrad.com

